

Ghid de instalare a boxelor



©2014 Sony Corporation

BDV-N7200W/N7200WL/N5200W

Montarea boxelor pe carcasă

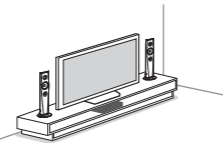
BDV-N7200W
BDV-N7200WL → **A**

BDV-N5200W → Așezați-o direct

Montarea boxelor pe perete

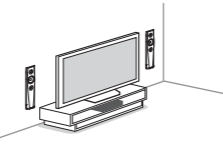
BDV-N7200W
BDV-N7200WL → **B**

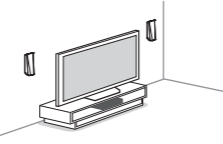
BDV-N5200W → **C**

Atenție

- Contactați un atelier de montaj sau un instalator pentru detalii legate de șuruburile adecvate pentru materialul peretelui sau de rezistența acestuia.
- Sony nu este responsabil pentru accidente sau daune cauzate de montarea necorespunzătoare, de rezistența insuficientă a peretelui sau de montarea necorespunzătoare prin înșurubare, de calamități naturale etc.

A

Montarea boxelor pe carcasă

BDV-N7200W
BDV-N7200WL

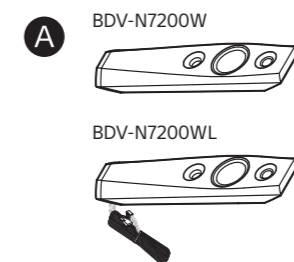

Boxă frontală stânga (L): Alb
 Boxă frontală dreapta (R): Roșu
 Boxă surround stânga (L): Albastru
 Boxă surround dreapta (R): Gri

* doar pentru BDV-N7200W



BDV-N7200W

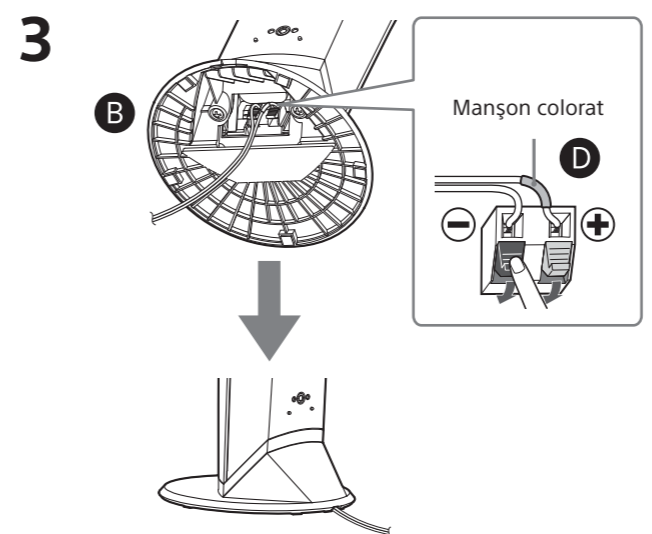
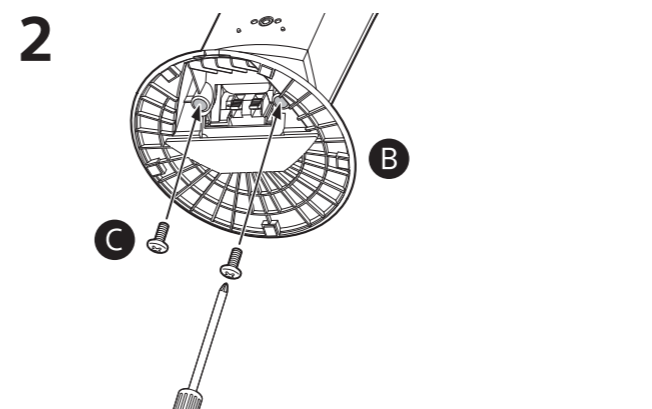
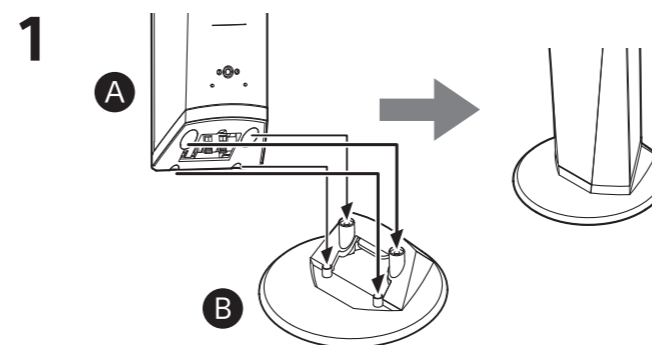

BDV-N7200WL

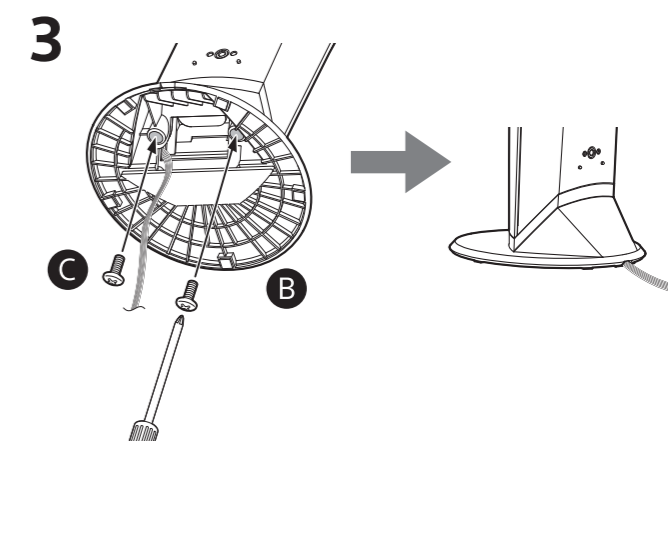
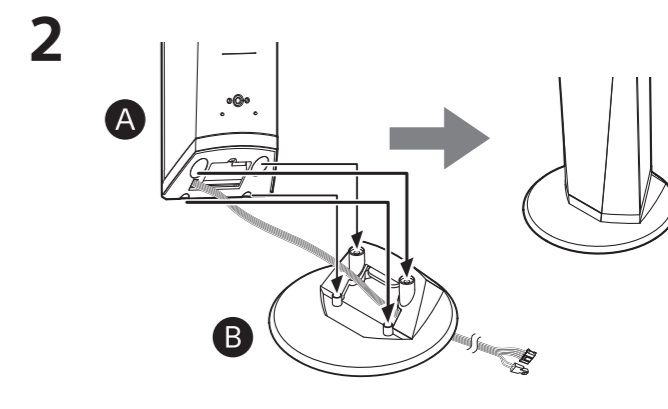
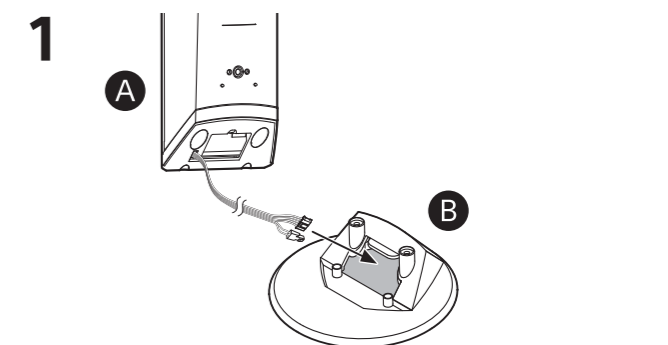

B

Montarea boxelor pe perete

BDV-N7200W
BDV-N7200WL



Boxă frontală stânga (L)*: Alb
Boxă frontală dreapta (R)*: Roșu
Boxă surround stânga (L)*: Albastru
Boxă surround dreapta (R)*: Gri
Boxă centrală: Verde
* doar pentru BDV-N7200W

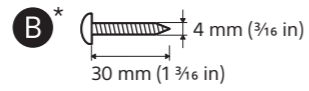

* Nefurnizat

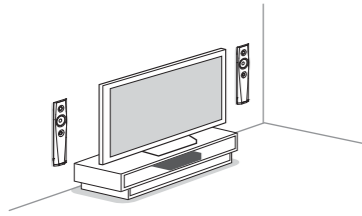
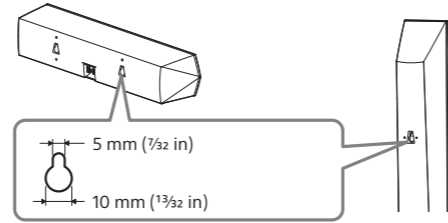

1

Pentru boxele frontale și surround (doar pentru BDV-N7200W)

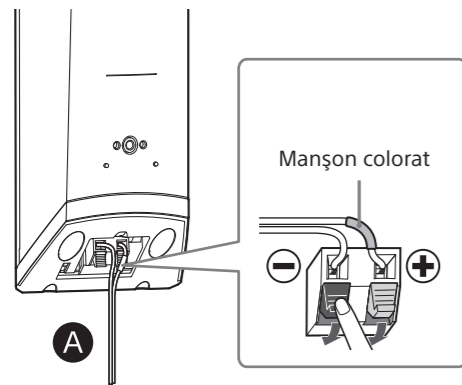

Pentru boxa centrală

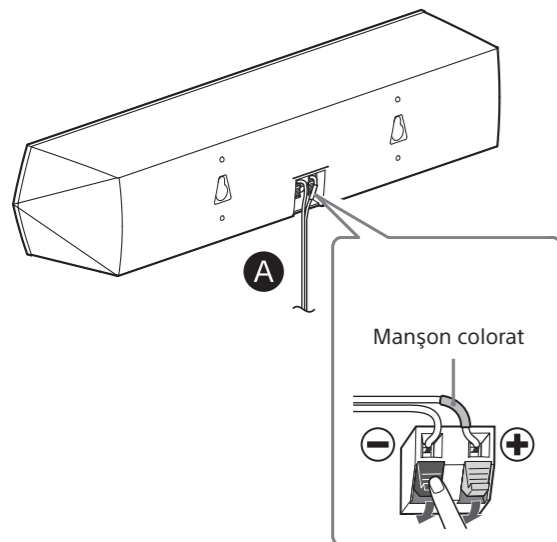

2

Pentru boxele frontale și surround

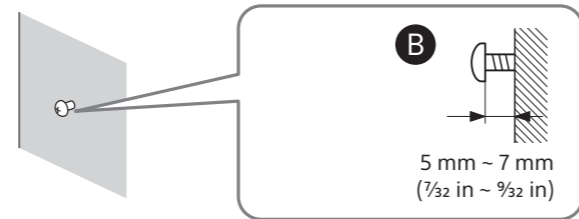

Pentru boxa centrală

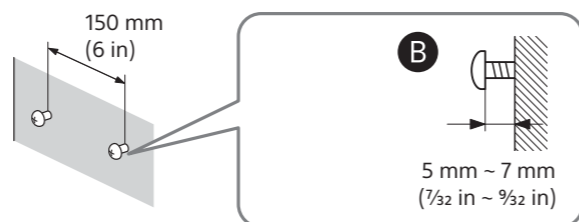

3

Pentru boxele frontale și surround

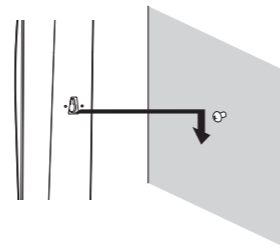

Pentru boxa centrală

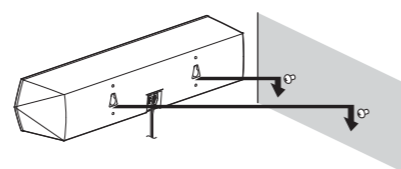

C

Montarea boxelor pe perete

BDV-N5200W

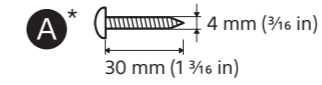

* Nefurnizat

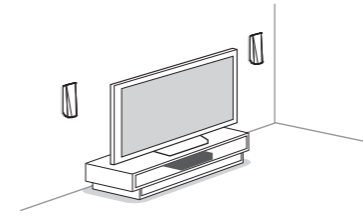
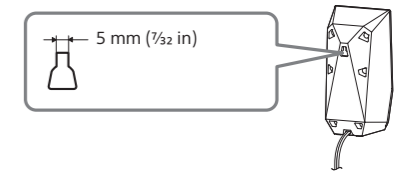
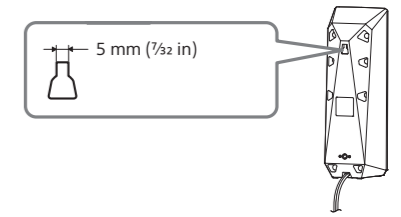

1

Pentru boxele frontale și surround

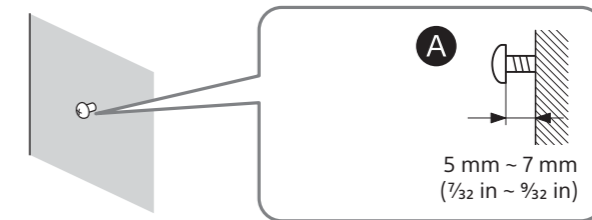

Pentru boxa centrală



2

Pentru boxele frontale

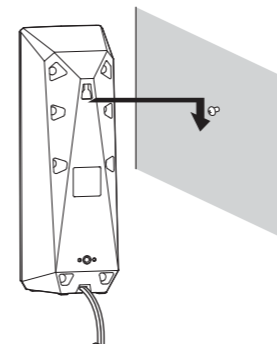

Pentru boxa centrală

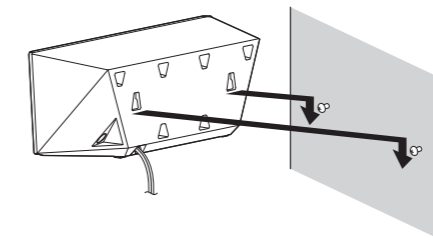

Pentru boxele surround

